

Alicate Ponteiras

Descrição

Ferramentas para uso profissional e intensivo.

Na gama de alicates de ponteiras tem disponibilidade de cravação de 0.08 a 150mm². Design ergonómico para reduzir o esforço na cravação.

CÓDIGO	REFERÊNCIA	CRAVAÇÃO (mm ²)	COMPRIMENTO (mm)	PESO (kg)
7070101002	CT 0.25-2.5	0.25-2.5	145	0.12
7070101004	CT 1.5-6	1.5-6	145	0.12
7070101006	CT 10-35	10-35	220	0.25
7070101008	CT 50WF	10-50	275	0.56
7070101010	CT 95WF	50-95	275	0.56
7070101012	CT 150WF	120-150	360	0.57
7070101016	CT8 6-4A	0.08-10	175	0.4
7070101018	CT8 6-6A	0.08-6	175	0.41
7070101020	CT8 6-4C	0.08-10	175	0.41
7070101022	CT10 16-4A	0.08-16	230	0.5
7070101024	CT9 10-6A	0.08-10	175	0.42
7070101026	CT9 16-4A	0.08-16	175	0.42
7070101028	CT11 10-4A	0.08-16	195	0.37
7070101030	CT12 16-6A	0.08-16	230	0.5

CT 0.25-2.5

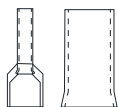

0.25-2,5
mm²

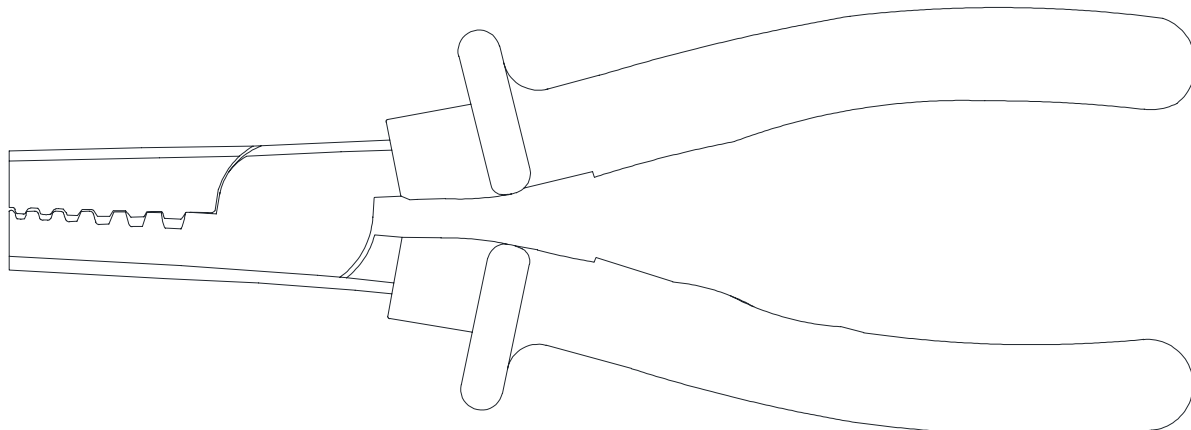

145 mm

CT 1.5-6

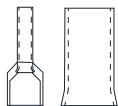

1.5-6
mm²

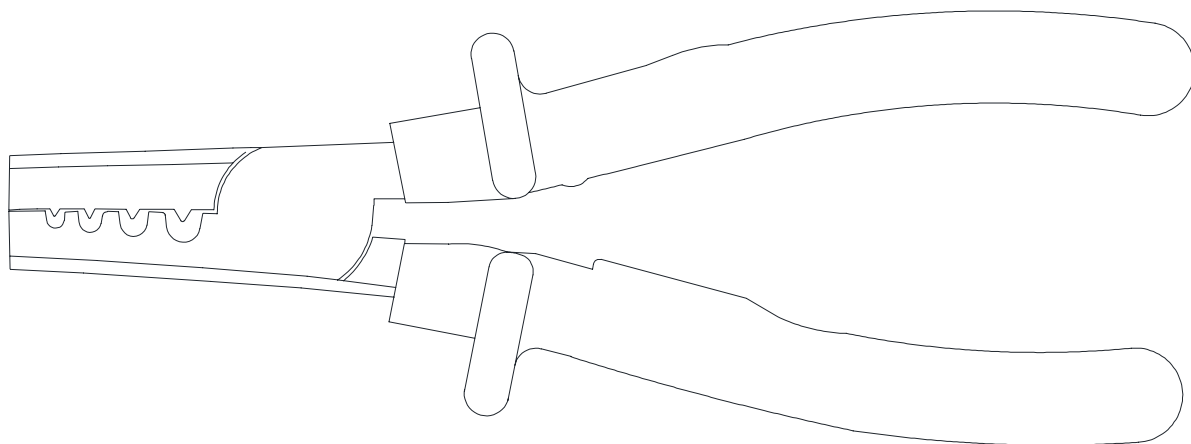

145 mm

CT 10-35

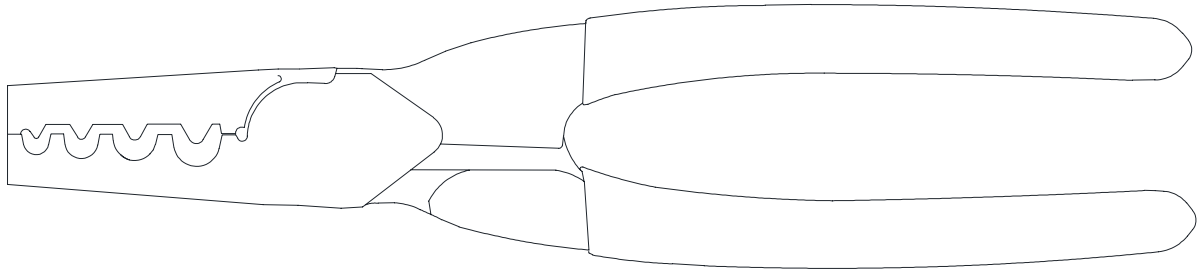

220 mm

CT 50WF

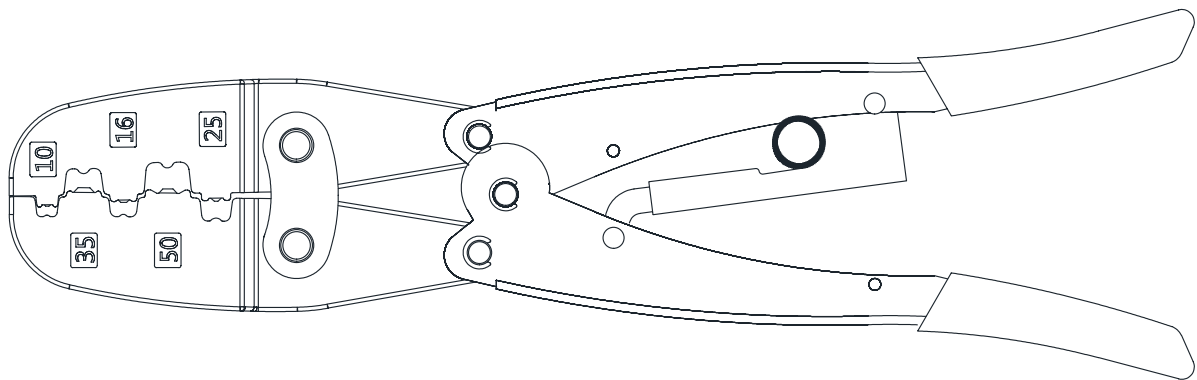

275 mm

CT 95WF

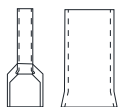

50-95
mm²

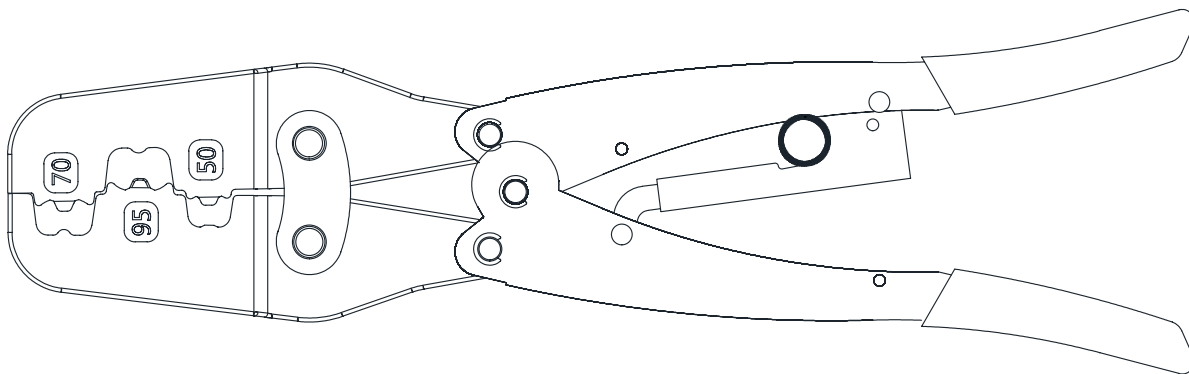

275 mm

CT 150WF

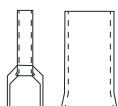

120-150
mm²

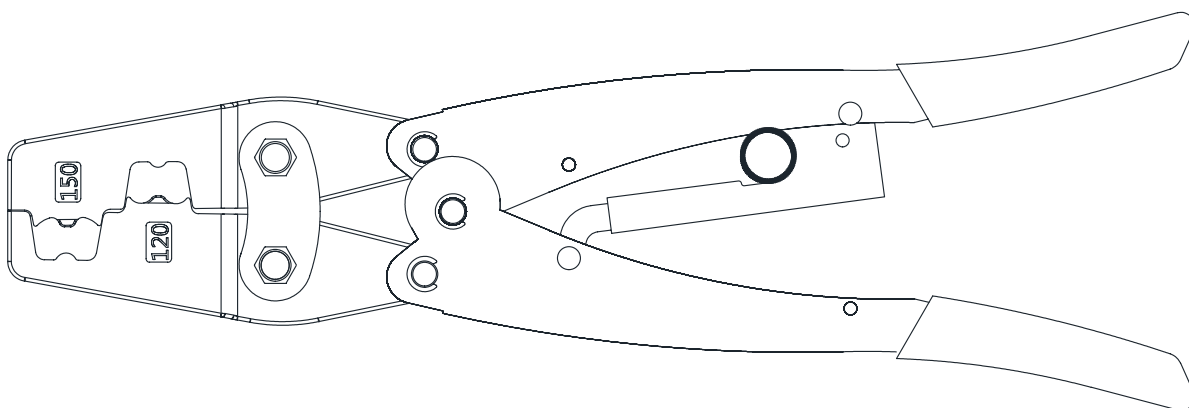

360 mm

CT8 6-4A

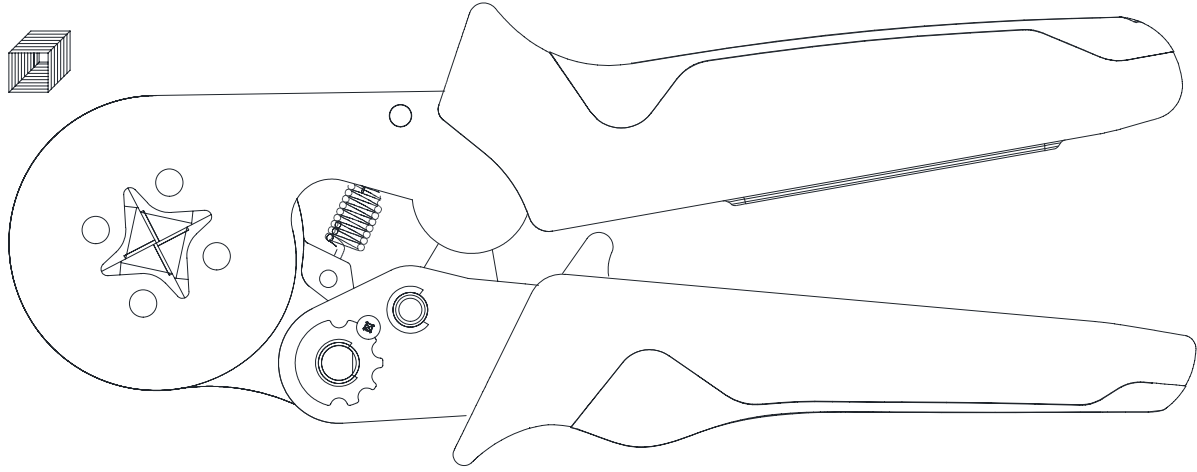
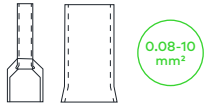

175 mm

CT8 6-6A

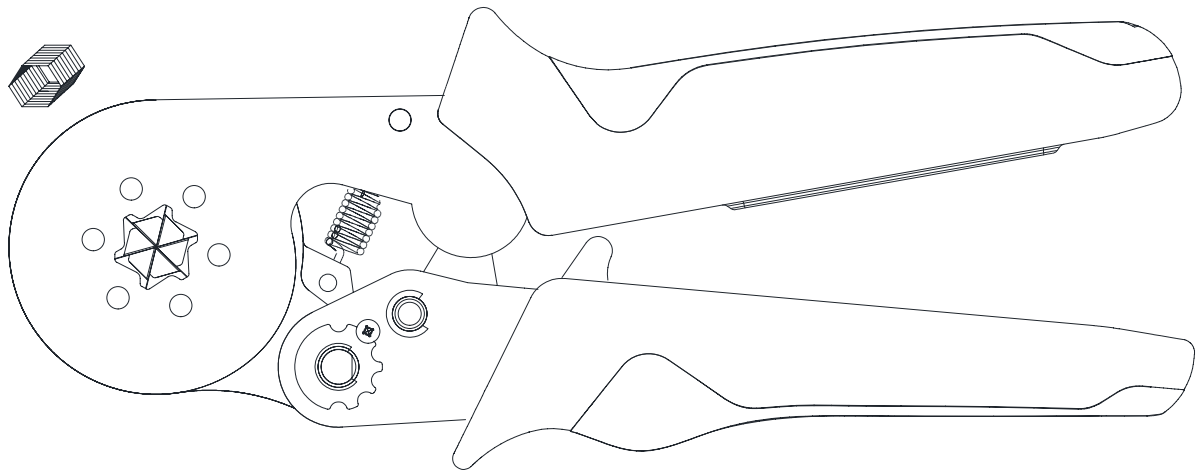

175 mm

CT8 6-4C

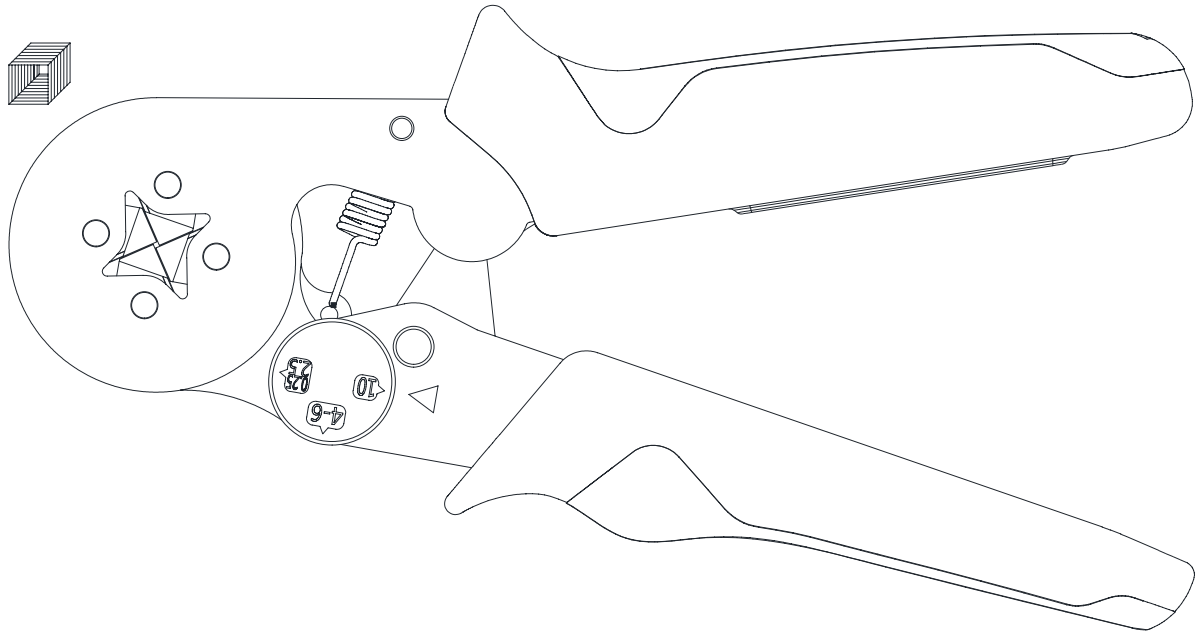
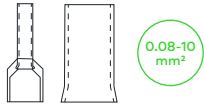

175 mm

CT10 16-4A

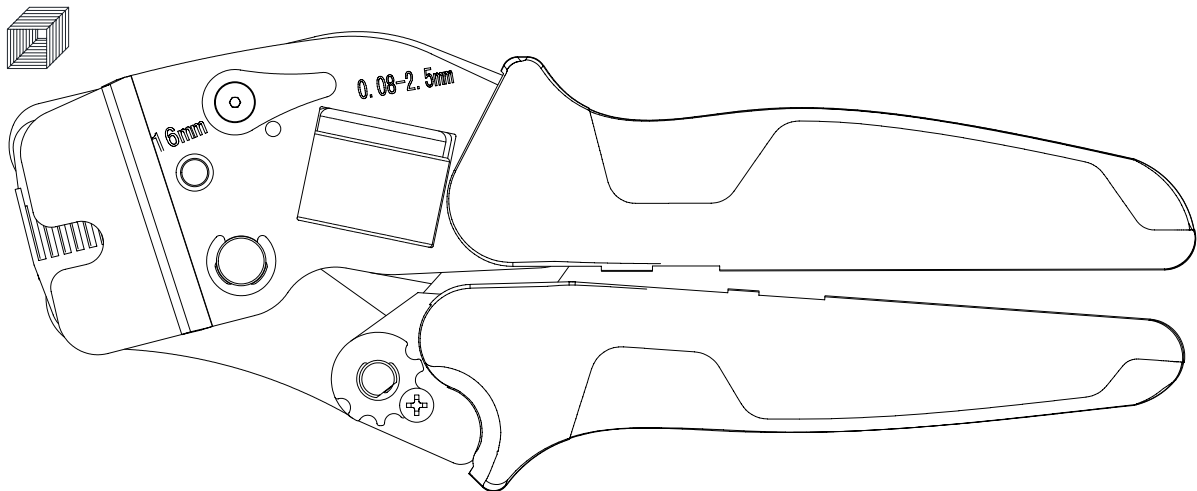

230 mm

CT9 10-6A

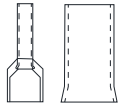

0.08-10
mm²

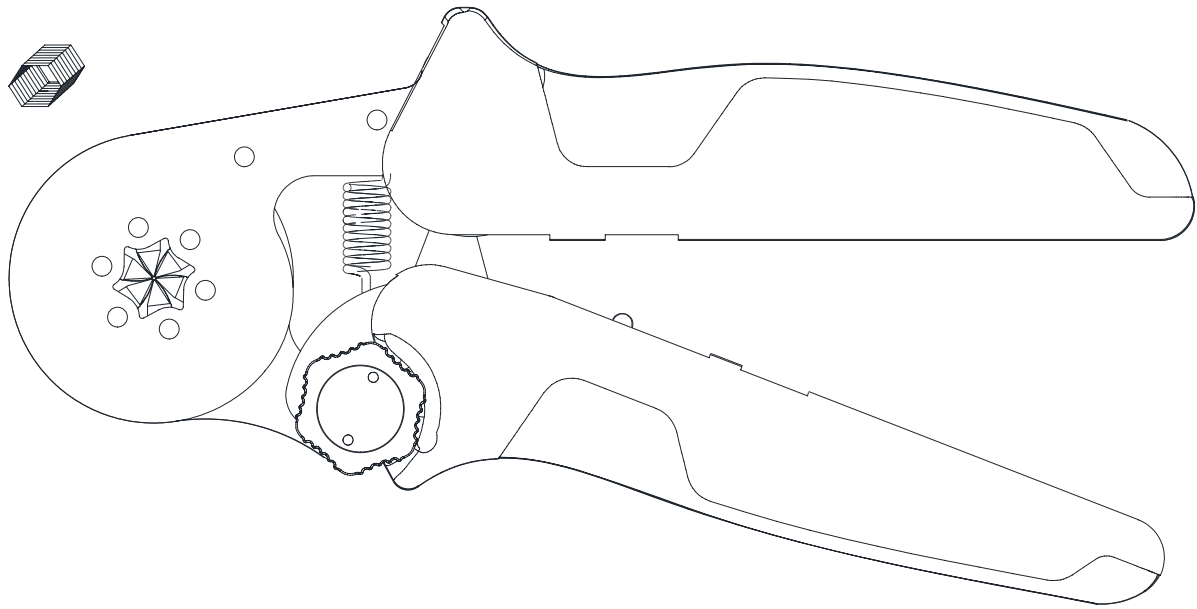

175 mm



CT9 16-4A

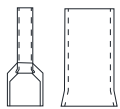

0.08-16
mm²

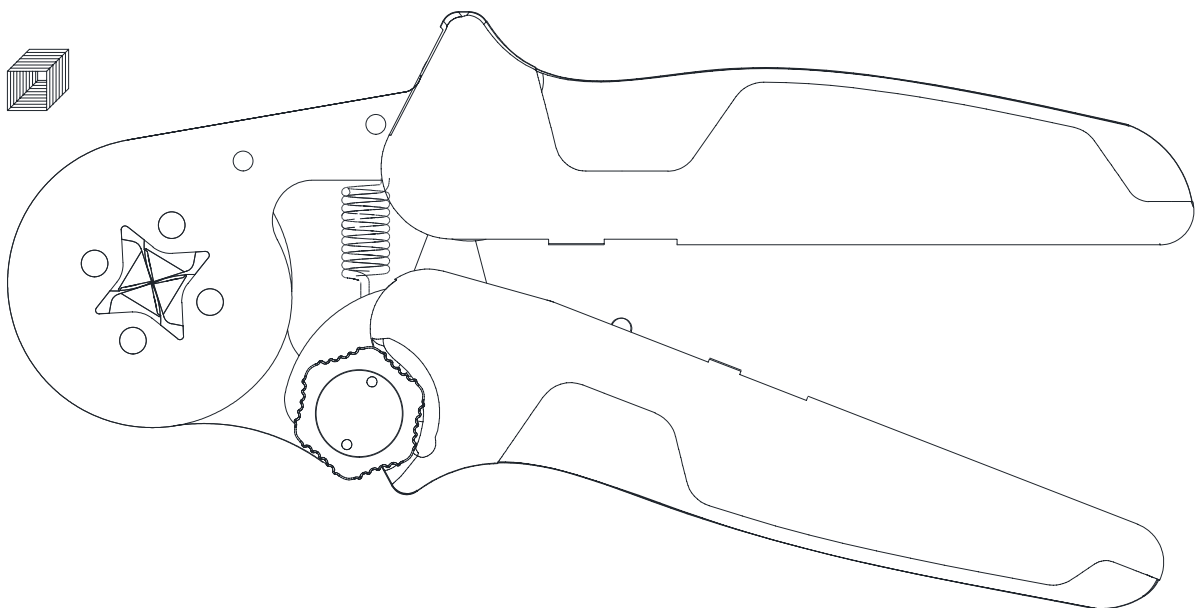

175 mm



CT11 10-4A

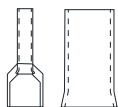

0.08-16
mm²

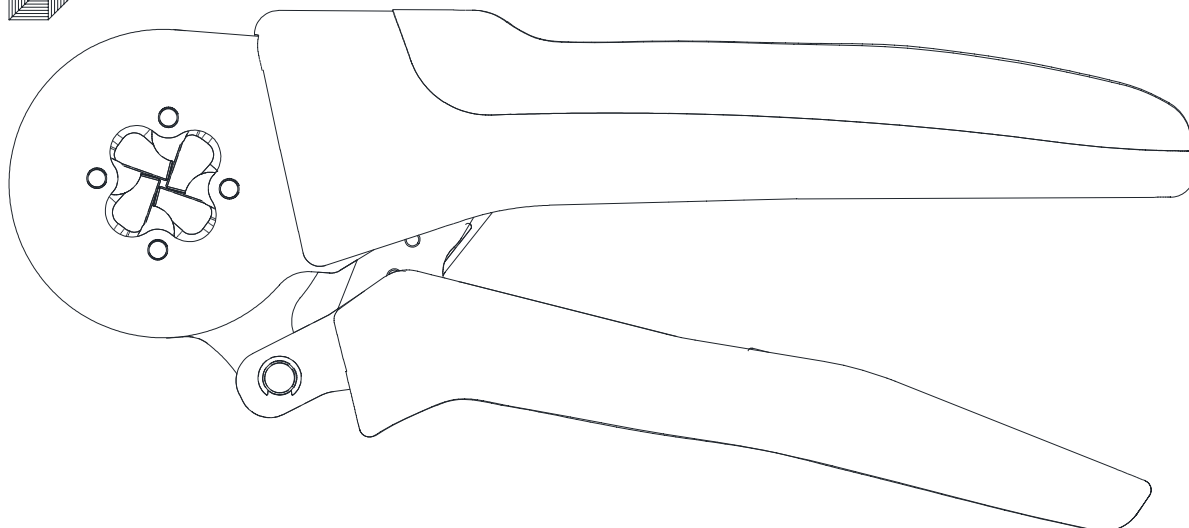

195 mm

CT12 16-6A

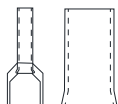

0.08-16
mm²

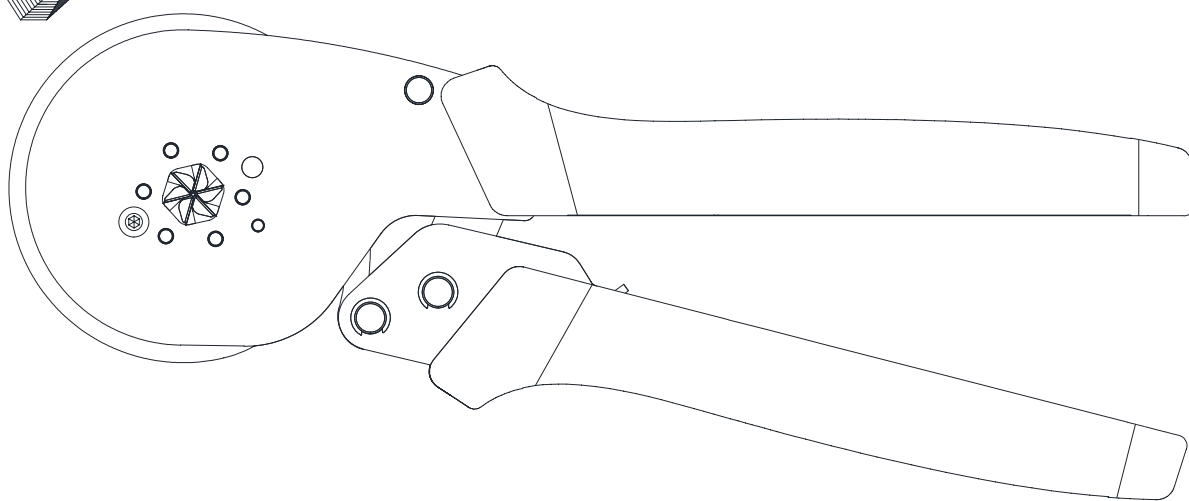

230 mm