

# Alicate Corte Cabo

## Descrição

Alicates de corte ideais para uso profissional e intensivo. Apresentam um design ergonómico para reduzir o esforço no corte. As lâminas de corte são em aço temperado, fazendo que os cortes sejam bastante precisos.

CÓDIGO	REFERÊNCIA	CABO	Ø CORTE (mm)	SECÇÃO CORTE (mm <sup>2</sup> )	ABERTURA CORTE (mm)	COMPRIMENTO (mm)	PESO (kg)
7070200002	AC-30A	CU   AL	32	-	-	230	0.4
7070200004	AC-36A	CU   AL	36	-	-	260	0.6
7070200006	AC-60A	CU   AL	60	-	-	320	0.8
7070200008	AC-32A	CU   AL	32	-	-	360	0.7
7070200010	AC-52A	CU   AL	48	-	-	415	1.2
7070200012	ASJ-36A	CU   AL	36	-	-	250	0.61
7070200014	ASJ-60A	CU   AL	60	-	-	310	0.84
7070200016	AC-150G	CU   AL	-	150	-	300	0.7
7070200018	AC-300G	CU   AL	-	300	-	600	1.2
7070200020	AC-500G	CU   AL	-	500	-	800	2.8
7070200022	AK-35	CU   AL	-	≤35	-	160	0.13
7070200024	AK-60	CU   AL	-	≤60	-	200	0.3
7070200026	AS-50A	CU   AL	-	35	-	200	0.1
7070200028	AK-22A	CU   AL	-	25	-	160	0.19
7070200030	AK-38A	CU   AL	-	35	-	190	0.3
7070200032	AK-60A	CU   AL	-	60	-	210	0.4
7070200034	AJ 101-5"	-	-	-	18	135	0.19
7070200036	AJ 101-6"	-	-	-	20	165	0.19

## AC-30A

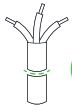

Ø32  
mm

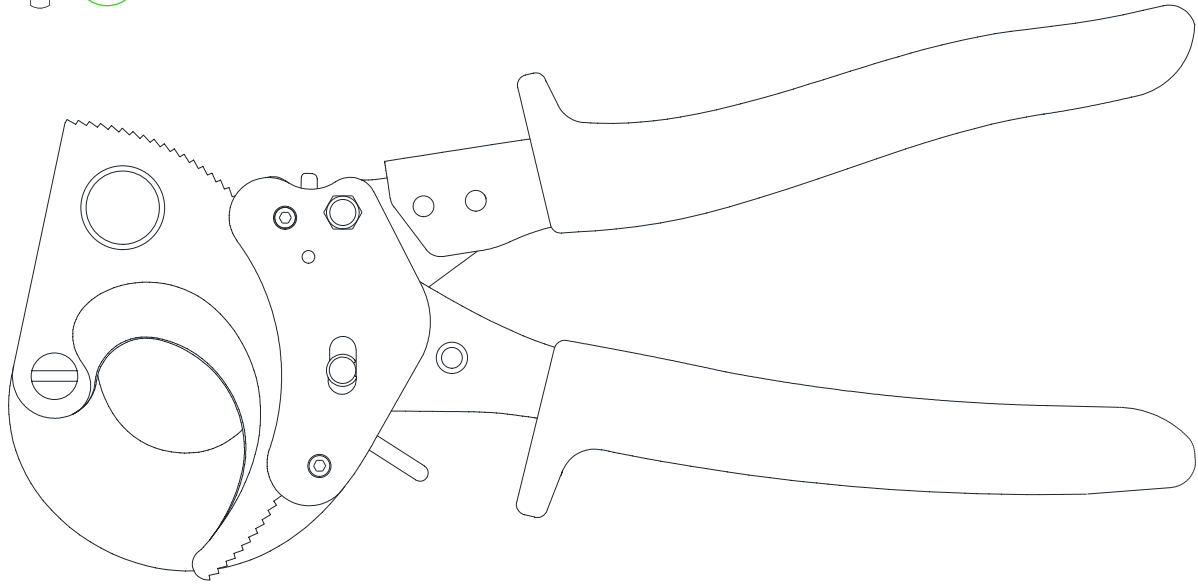

230 mm

## AC-36A

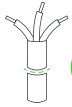

Ø36  
mm

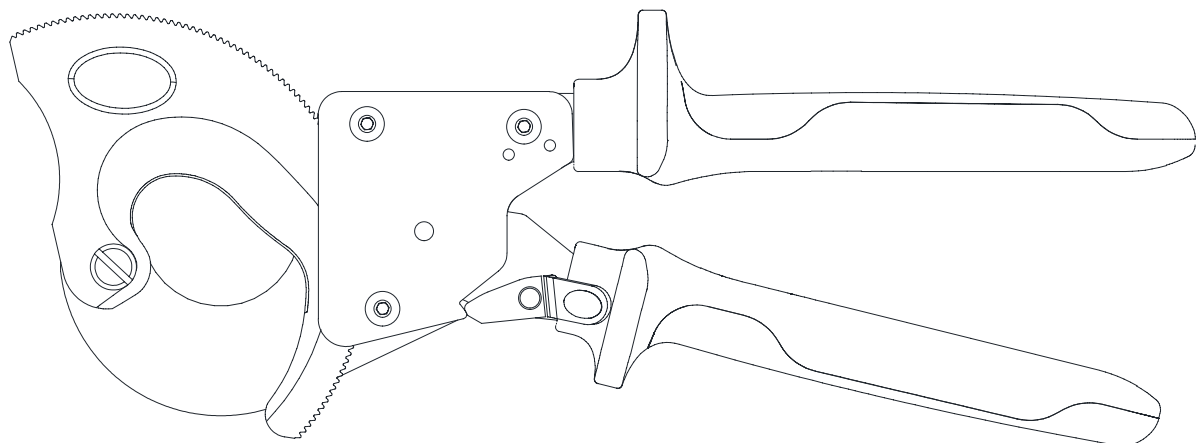

260 mm

## AC-60A

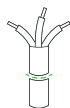

Ø 60 mm

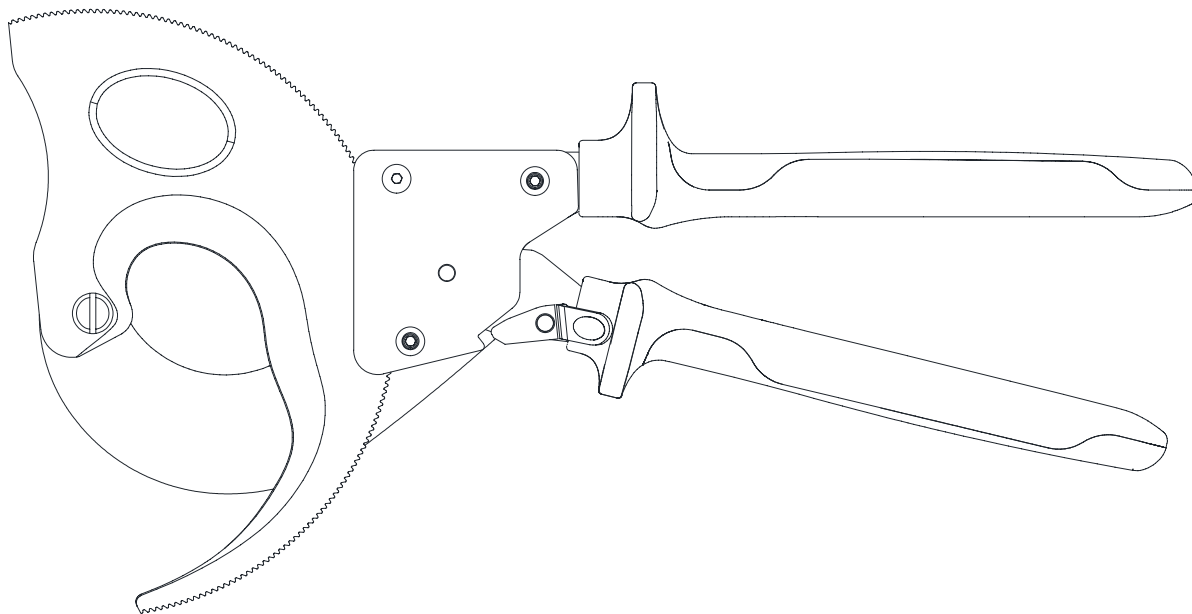

320 mm

## AC-32A

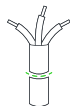

Ø 32 mm

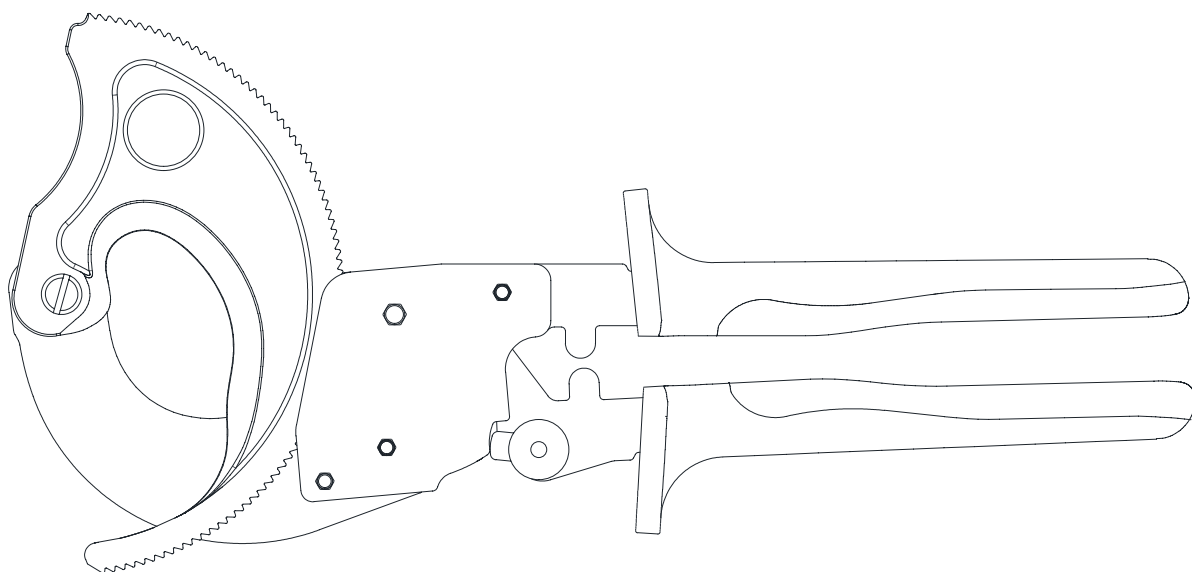

360 mm

## AC-52A

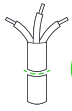

Ø48 mm

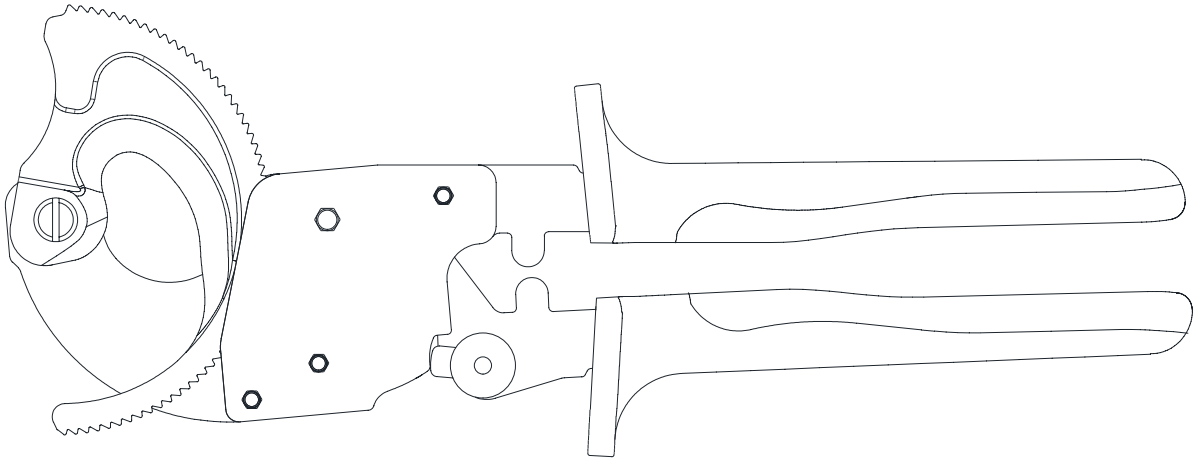

415 mm

## ASJ-36A

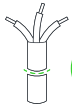

Ø36 mm

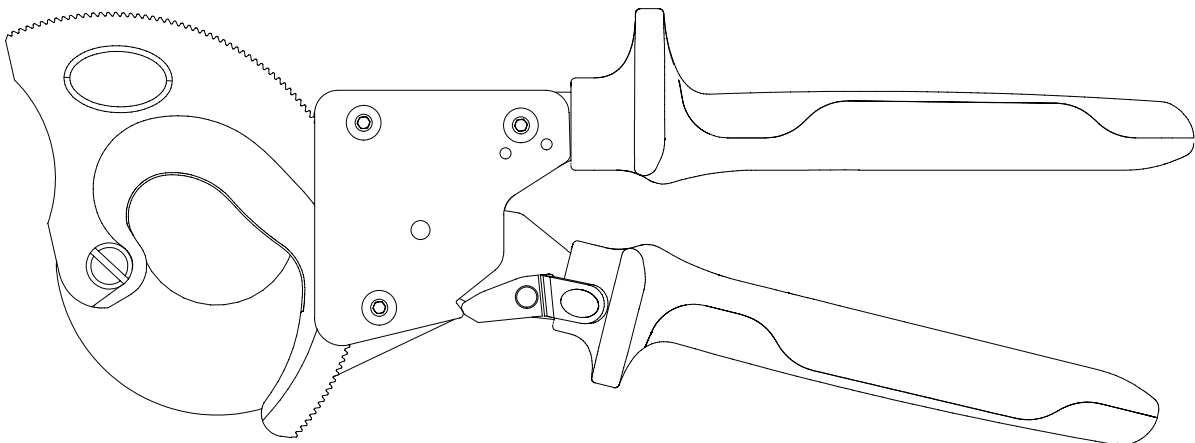

250 mm

## ASJ-60A

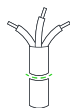

Ø60  
mm

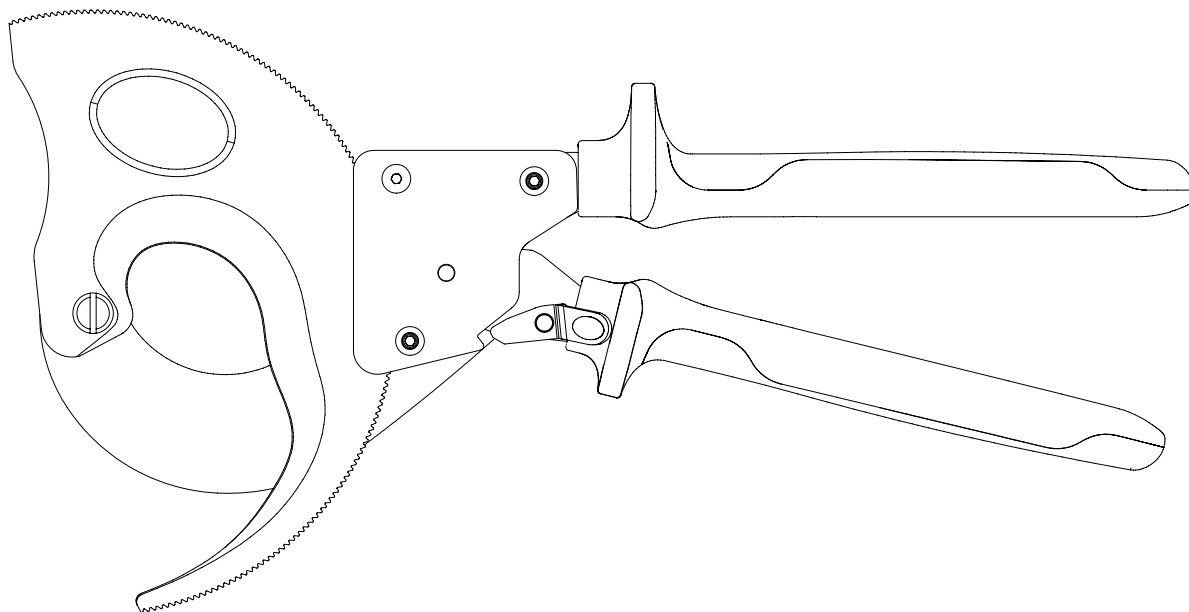

310 mm

## AC-150G

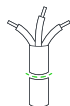

150  
mm<sup>2</sup>

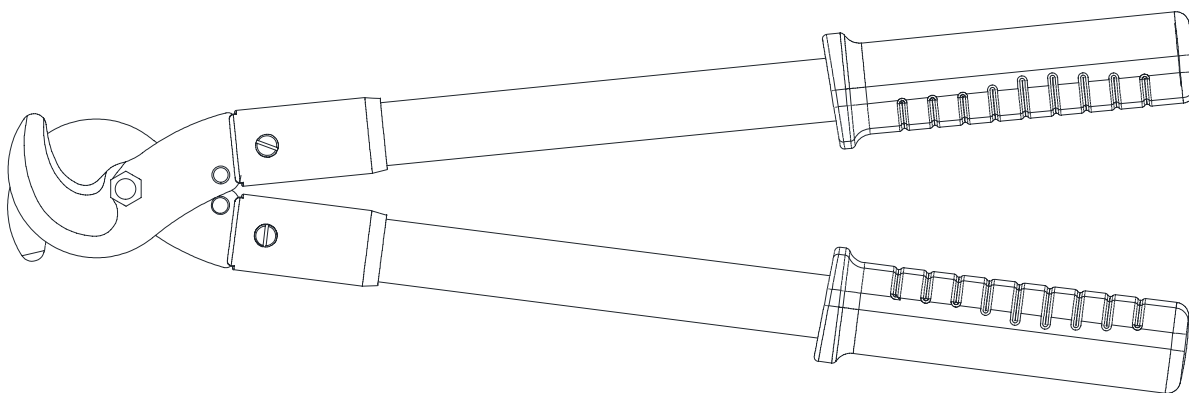

300 mm

### AC-300G

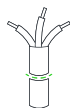

300  
mm<sup>2</sup>

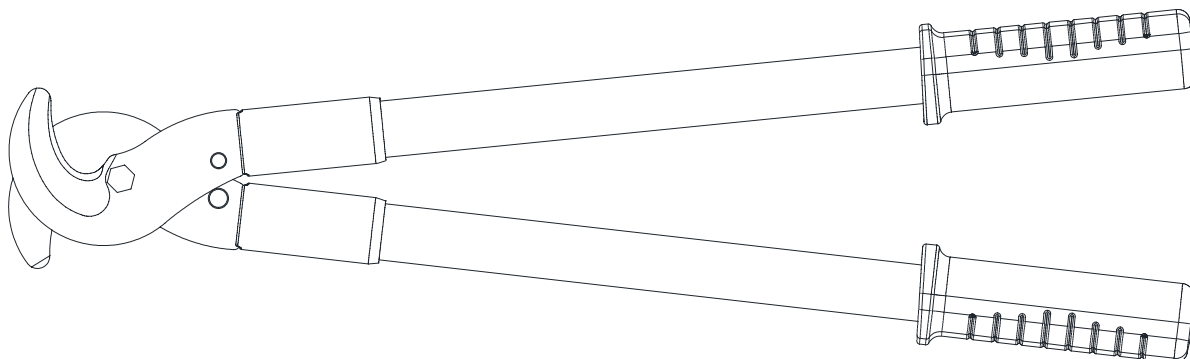

600 mm

### AC-500G

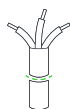

500  
mm<sup>2</sup>



800 mm

## AK-35

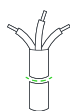

≤35  
mm<sup>2</sup>

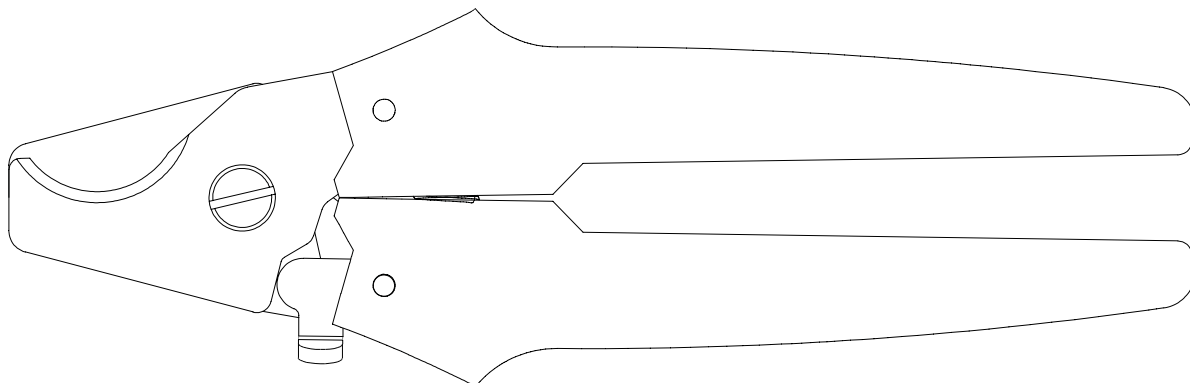

160 mm

## AK-60

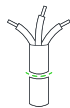

≤60  
mm<sup>2</sup>

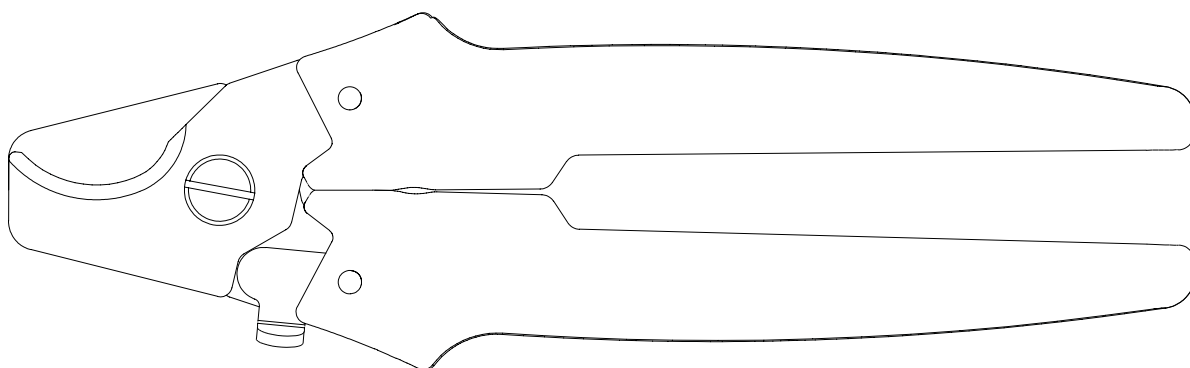

200 mm

## AS-50A

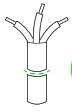

35  
mm<sup>2</sup>



Em desenvolvimento

200 mm

## AK-22A

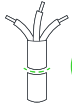

25  
mm<sup>2</sup>

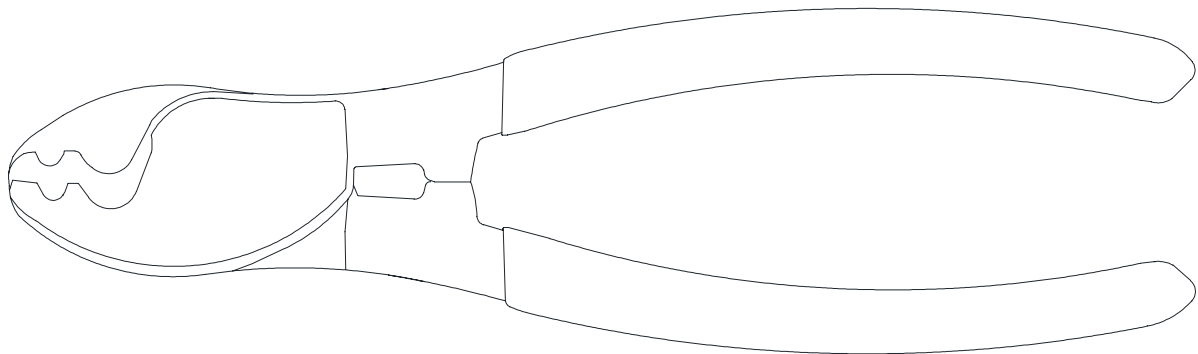

160 mm



## AK-38A

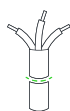

35  
mm<sup>2</sup>

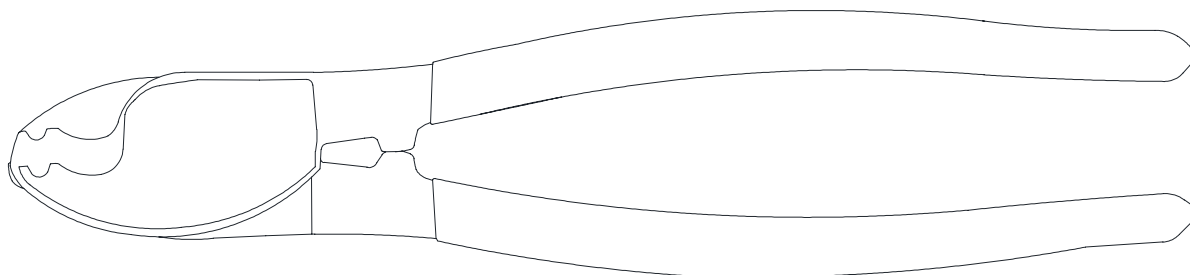

190 mm

## AK-60A

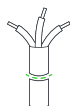

60  
mm<sup>2</sup>

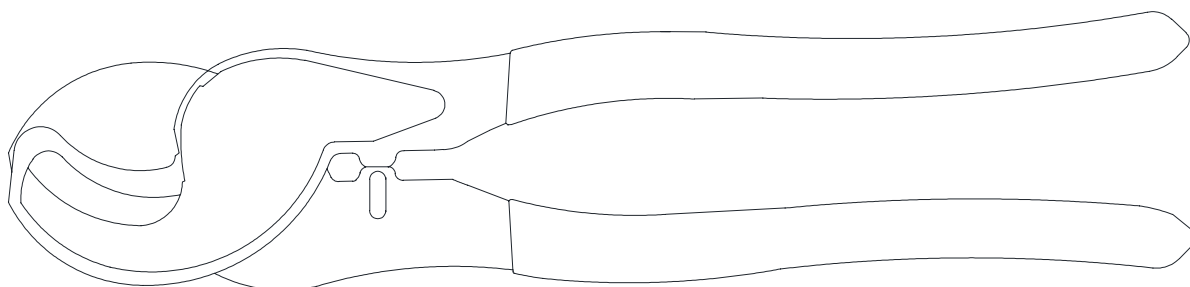

210 mm

## AJ 101-5"



18 mm

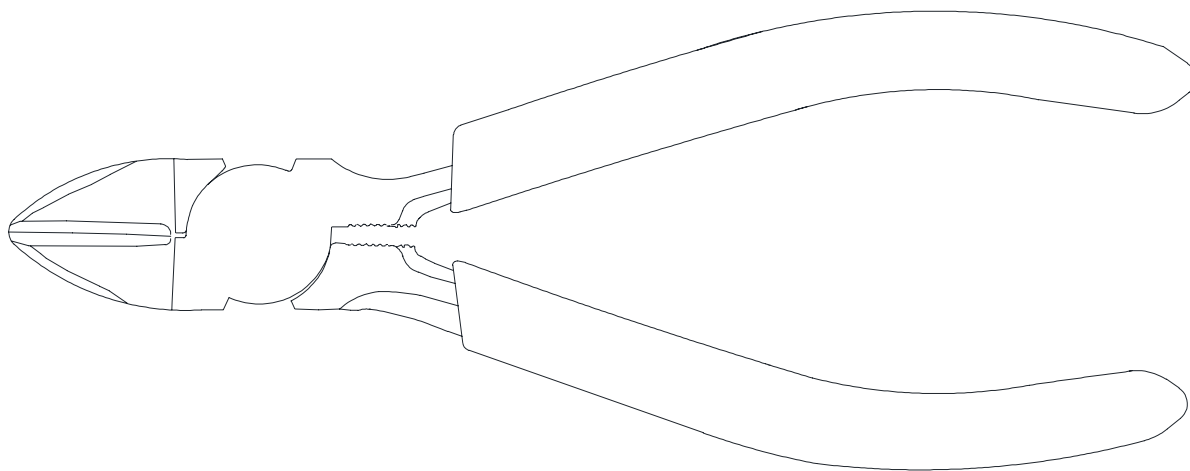

135 mm

## AJ 101-6"



20 mm

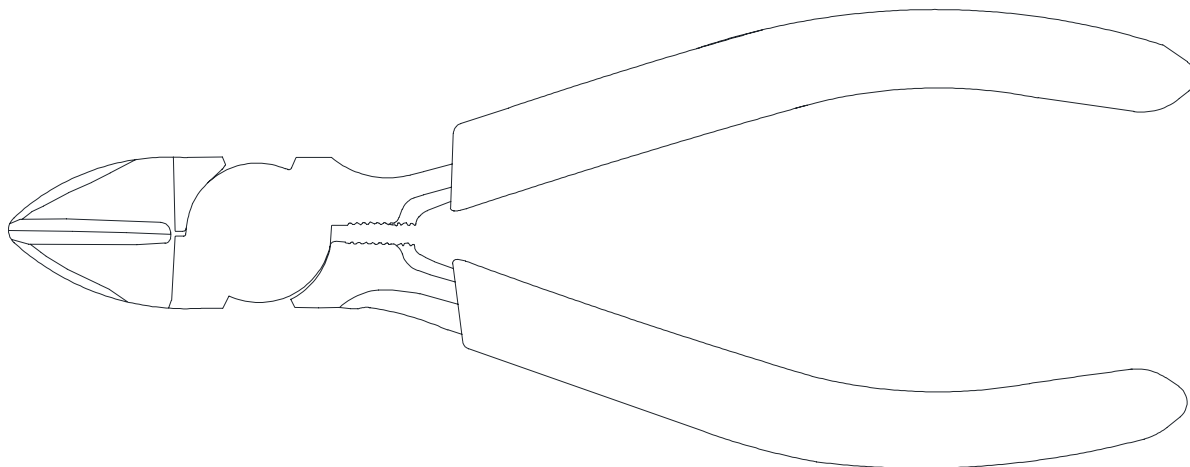

165 mm